

Insta360 Wave

User Manual

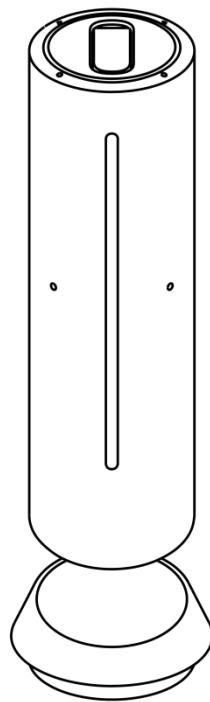

Content

OVERVIEW	1
Appearance	2
Standard Accessories	3
Screen Display	4
Indicator Light	5
USAGE	6
Placement and Movement	6
Power On/Off	7
Charging	8
Connect to Use as an Audio Input/Output Device	9
Audio Recording and File Management	11
Setting Audio Mode	13
ADVANCED USE	15
Wi-Fi Connection	15
Installing Insta360 Wave Controller	16
Using Insta360 InSight AI Features	17
Using with Insta360 Link 2	19
Multi-Device Wireless Connection	21
AI Pre-Recording	21
MAINTENANCE	22
Find Your Serial Number	22
Update Firmware	24
Storage and Maintenance	25
SAFETY INFORMATION	26
SPECIFICATIONS	27

Overview

Insta360 Wave is an AI-powered omnidirectional microphone that integrates microphone, speaker, and recording functions, which offers:

360-Degree Omnidirectional Audio Capture: Comprehensive sound pickup with a 3D 8-microphone array.

Intelligent Noise Reduction: Utilizes AI technology to effectively eliminate various types of environmental noise, enhancing audio clarity.

Five Pickup Patterns: Supports five pickup patterns, including omnidirectional and cardioid, to adapt to different scenarios.

AI Meeting Assistant: Supports voice transcription and generation of meeting minutes.

Device Integration: Can integrate with Insta360 Link 2, allowing the webcam to automatically follow a speaker.



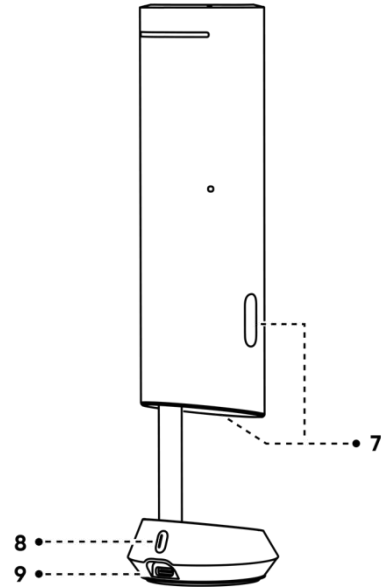
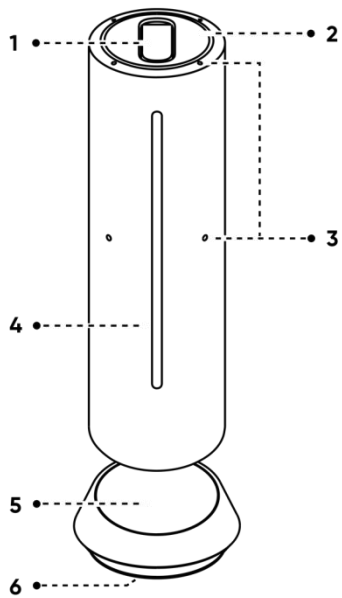

Appearance



1. Dongle
2. Top Cover
3. Microphone
4. Indicator Light
5. Touchscreen
6. Suction Cup

7. Speaker
8. Power Button
9. USB-C Port

Standard Accessories

	<p>Dongle (attaches to top cover for secure storage)</p>
	<p>1.5m USB-C Cable</p>
	<p>USB-A to USB-C Adapter</p>
	<p>Carry Bag</p>

Screen Display

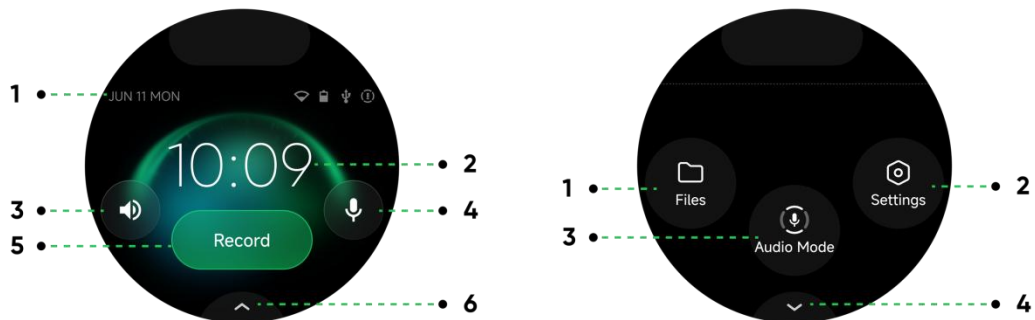

Main Screen:

1. Status Bar: Displays date, Wi-Fi, battery level, Bluetooth, pickup pattern, and other relevant information.
2. Time: Shows the local time of the device.
3. Speaker: Adjust speaker volume or turn the speaker on/off.
4. Microphone: Turns the microphone on or off.
5. Record Button: Tap to start audio recording.
6. More Functions: Tap to enter the secondary screen with wider configuration options.

Secondary Screen:

1. Files: View all recorded audio files.
2. Settings: Manage AI features, network, password, USB mode, device height, language, and more.
3. Audio Mode: Choose whether to enable noise reduction, or select different pickup patterns (Omnidirectional, Cardioid, Supercardioid, Figure-8, or Stereo).
4. Back Button: Tap to return to the main screen.

With Link 2 Connected:

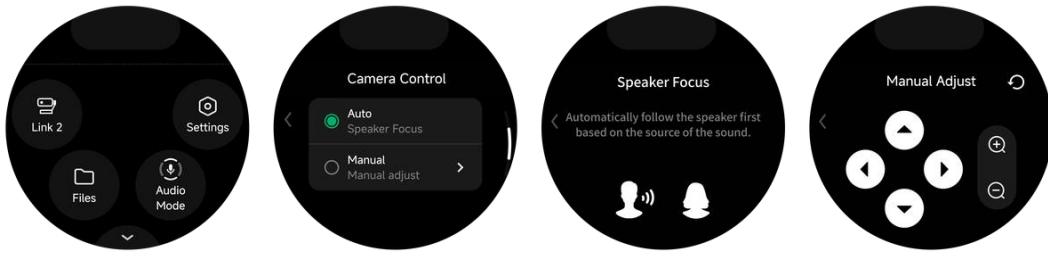

Once Link 2 is connected, a Link 2 icon will appear on the secondary screen. Tap it to select the camera control mode:

1. Speaker Focus: Automatically follows a speaker based on source of sound.
2. Manual Adjust: Manually adjust camera angle and zoom.

Indicator Light

Device Status	Indicator Light Status
Powered on / Bluetooth paired successfully / Powered off and fully charged	Solid green
Powered off and charging	Slowly flashing orange
Firmware updating	Pulsing blue
Microphone muted	Solid red
In a conference call / AI recording in progress	Solid cyan
Hardware malfunction / Bluetooth pairing failed / Firmware update failed	Flashing yellow
Device height adjusting	Pulsing cyan

Usage

Placement and Movement

Before use, please ensure that your desired surface is flat, smooth, and clean.

Insta360 Wave is equipped with a suction cup at the bottom. After placing it in the desired position, press down slightly to secure it firmly.

If you need to fix the device on the desktop, a Table Mount (sold separately) can be used.

To move the device, hold the top of the device, tilt it to one side, and lift upwards to release suction and move the device.

Cautions:

- To adjust the device's height, power on the device, then go to Settings.
- You'll find a built-in pressure sensor and speaker inside the main body of the device. Do not press or dig into this area.

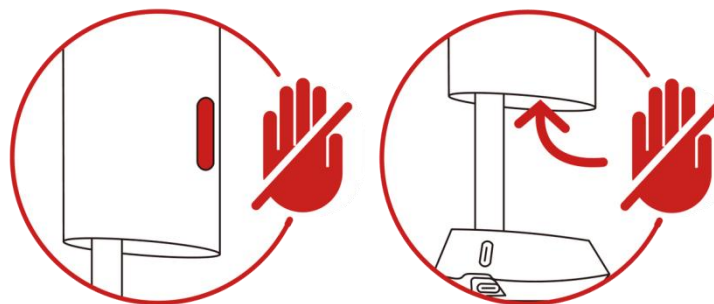

Power On/Off

Power On: Press and hold the Power Button to power on Insta360 Wave. The main body of the speakerphone will rise. Press the Power Button once to turn the touchscreen off or on.

Power Off: Press and hold the Power Button to power off Insta360 Wave. The main body will lower. When the device is off, press the Power Button once to check the battery level via the indicator light.

Insta360 Wave will automatically power on when connected to an external power source using a USB-C cable.

Note:

- Upon first powering on the device, follow the on-screen instructions to complete the initial setup before accessing the main home screen.
- Ensure nothing obstructs the device from being extended or retracted when it is powering on or off.

Charging

To charge Insta360 Wave, connect it to a charger using the included USB-C cable.

Once connected successfully, the device will automatically power on, and the battery icon on the screen will indicate that it is charging.

You can long-press the Power Button to turn it off while it continues charging; the indicator will flash orange slowly. Press the Power Button briefly to check the battery level, shown by the green indicator light. When fully charged while off, the indicator light will stay solid green.

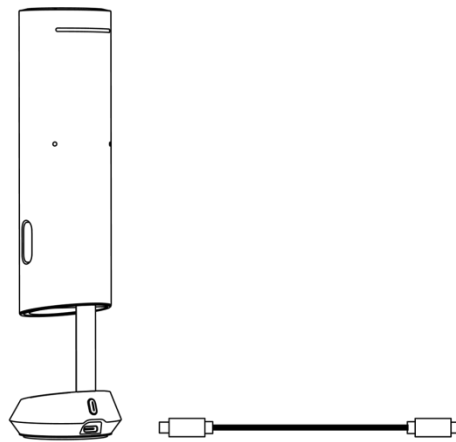

Connect to Use as an Audio Input/Output Device

Connecting

- **Via USB-C Cable**

Insta360 Wave is compatible with both Windows and macOS systems. To avoid compatibility issues, it is recommended to use the included USB-C cable to connect it to your device.

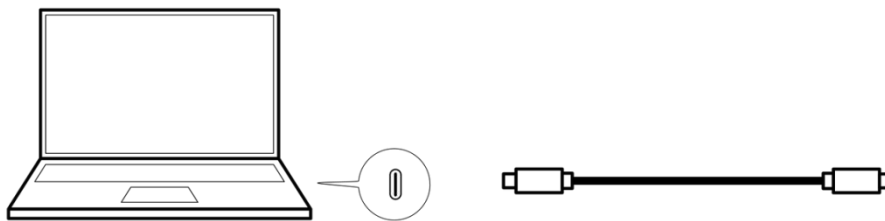

- **Via Dongle**

Remove the Dongle from Insta360 Wave and insert it into a computer or other device to connect.

The Dongle features a USB-A port. You can also use the included USB-A to USB-C Adapter to connect the dongle to your device's USB-C port.

When connecting the Dongle for the first time, it will automatically pair with Insta360 Wave without any manual operation required from the user. If the original Dongle is lost or damaged, the user will need to unbind it in the settings page and bind a new one.

Tips: When storing the Dongle, please place it according to the orientation indicated by the silk-screen in the storage slot to ensure a secure fit.

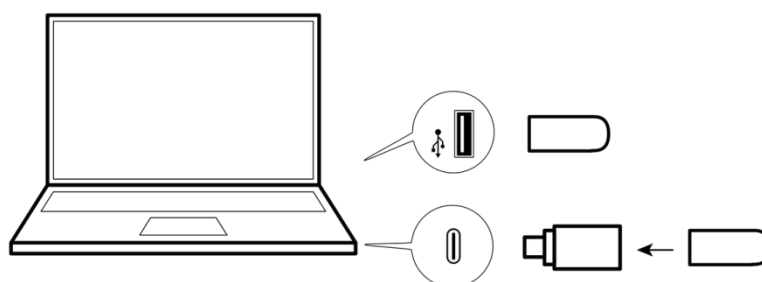

- **Via Bluetooth**

1. On the touchscreen, go to "More > Settings > Bluetooth" to enable it.
2. In the Bluetooth settings of your phone/computer, search for and connect to the device name displayed on the touchscreen.
3. After enabling the "Auto Reconnect" feature, the device can automatically connect to the most recently connected device.

Set as Audio Device

Once connected, set the Insta360 Wave as the audio input and output device in the system settings or within conferencing software.

Adjust Speaker and Microphone

Once connected, you can control the device using the speaker and microphone buttons on the touchscreen.



No.	Button Name	Button Function
1	Speaker	Adjust speaker volume, turn the speaker on or off.
2	Microphone	Turn the microphone on or off.

Tips: To adjust the microphone volume, please go to the "Settings > Mic Volume" screen.

Audio Recording and File Management

Start/Stop Recording

- Before recording, place the device within 5 meters of the sound source to ensure clear audio quality.
- After powering on the device, tap the Record Button on the screen to begin recording.
- The screen will display the recorded duration and real-time captions (currently supporting five languages: Simplified Chinese, English, Japanese, German, and French, with more languages to be supported in the future).
- When recording, you can pause or stop the recording, and control the device's speaker and microphone via the touchscreen.

Tips:

- The device can be used as a standalone voice recorder or to record audio while connected to a computer or other device.

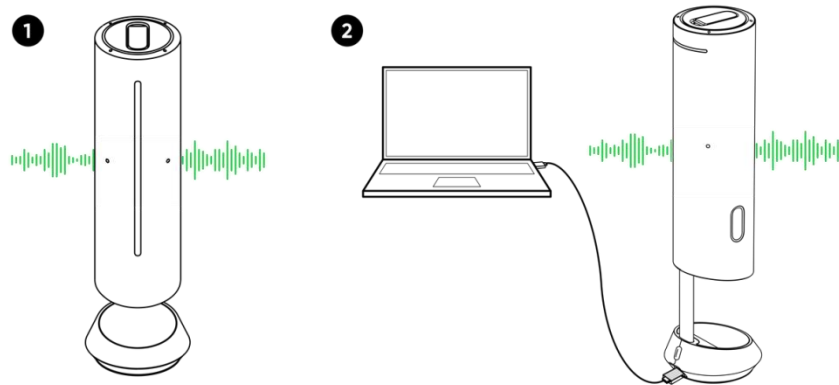

- By default, recordings are saved as MP3. You can enable "Lossless Audio" on the settings screen so that WAV lossless audio will also be saved internally.

Managing Audio Files

- After recording, all audio files are saved locally on the device.
- Go to "More > Files" to view audio files.
- Select a recording file to play it, adjust the volume, use AI summarization, mark as a favorite, or delete.
- Go to "Settings > USB Mode" to transfer files to a computer.
- You can set a six-digit password in "Settings" > "Password." After setting, this password will be required to access the audio files folder. The password can be reset via the Insta360 account's registered email or phone verification.

Setting Audio Mode

The device supports multiple audio modes. Whether used as a microphone or during recording, it's important to select the best mode based on your conditions for an optimal result.





Freely select your desired audio mode by tapping More > Audio Mode.

- **Noise Reduction**

Eliminates environmental noise, ideal for meetings.

- **Original**

Preserves natural, authentic audio with five patterns.

Pattern Type	Pattern Diagram	Description
Omnidirectional		Captures sound from all directions, ideal for group or roundtable discussions.
Cardioid		Captures sound from the front, ideal for live streaming or podcasting.
Supercardioid		Captures sound from the front with a narrower pickup range than cardioid, ideal for personal meetings in an open space.
Figure-8		Captures sound from both front and back, ideal for face-to-face interviews.

Stereo	 A circular icon representing a stereo pickup pattern. It features a central microphone symbol with two curved lines extending outwards to the left and right, indicating sound capture from both sides. The background is a gradient of green and blue with faint concentric circles.	Uses left and right channels to capture sound, ideal for music performances (available only when the audio input source is USB).
--------	---	--

Note:

Currently, when used with Insta360 Link 2, only Noise Reduction and Omnidirectional are supported in order to ensure optimal voice-tracking performance. To use other pickup patterns, please set Insta360 Link 2 camera to manual adjustment first.

Advanced Use

Wi-Fi Connection

How to Connect

- Method 1: On the touchscreen, go to Settings > Wi-Fi.



- Method 2: After installing Insta360 Wave Controller on your computer and connecting the computer with the device via a USB cable, go to Settings in the software to set up Wi-Fi connection.

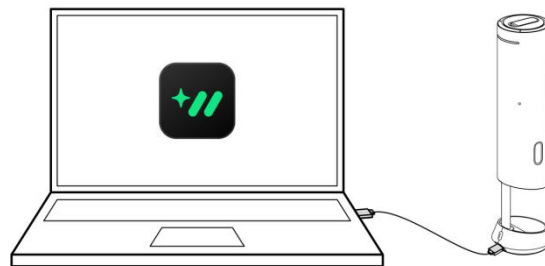

Functions

- With a Wi-Fi connection, you can use Insta360 InSight to upload your recording files to the cloud for transcription and meeting summary generation (Cloud Sync must be enabled).
- With Wi-Fi, the device will automatically detect if a firmware update is needed and download the latest firmware.

Installing Insta360 Wave Controller

By installing the Insta360 Wave Controller on your computer, you'll be able to:

1. Control the device via a computer, such as starting recording and quickly adjusting speaker volume.
2. Perform device-related settings via a computer, such as Wi-Fi settings and firmware upgrades.

How to Install

Method 1: Visit <https://www.insta360.com/download/insta360-wave> to download and install the software.

Method 2: Connect the Insta360 Wave to your computer using a USB-C cable, then enable USB Mode > File Transfer on the device to access and install the local client installation package.

First-Time Connection

1. Connect the Insta360 Wave to your computer using a USB-C cable.
2. Open Insta360 Wave Controller and log in to your Insta360 account.
3. The software will automatically detect the device. Confirm the correct device by checking the last five digits of the serial number shown below the device image, then pair it.
4. After pairing, you can adjust volume, record audio, and perform other operations from your computer. When the device is connected to Wi-Fi and cloud sync is enabled, recordings will be automatically uploaded to the cloud after completion. You can access Insta360 InSight via the client to view AI summaries.
5. During recording, you can use the mark and screenshot functions. Visit Insta360 InSight, find the audio file—marks and screenshot timestamps are shown on the audio progress bar, and screenshots appear on the transcription page. (This feature is available on the desktop client only.)

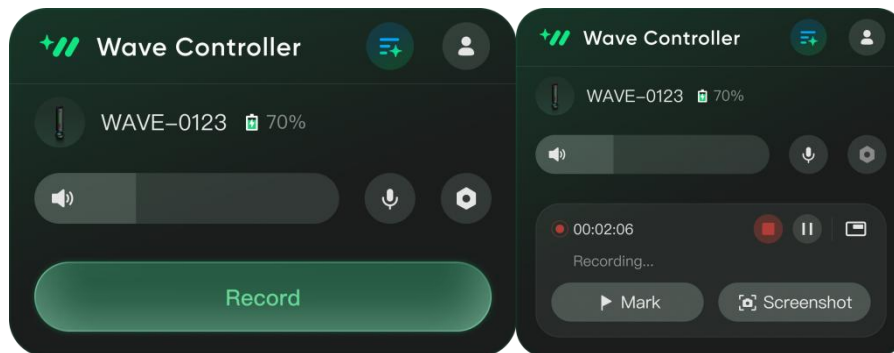

Using Insta360 InSight AI Features

After recording audio with the Insta360 Wave, you can use Insta360 InSight to access your cloud recordings, transcribe them into text with one click, and generate meeting summaries.

How to Activate

1. Connect the device to your computer using a USB-C cable.
2. Download and install the desktop client Insta360 Wave Controller.
3. Bind your account to activate AI features.

Once activated, go to Settings > AI Features to enable or disable Auto Summary, choose the transcription language, and view or upgrade your subscription plan. You can also enable or disable cloud sync under Cloud Management.

Access Methods

To access Insta360 InSight on your computer, click the InSight icon in the desktop client or visit <https://insight.insta360.com>.

How to Use

- After recording, on the touchscreen, go to More > Files and select the desired file. Tap the ai summary button, then scan the QR code displayed on the device screen to view the generated summary and transcription.
- Go to Settings > AI Features > Cloud Management and enable Cloud Sync. Once enabled, recordings will automatically upload to the cloud when the device is connected to the internet. You can view uploaded audio files on the InSight website and click Generate to create a summary.
- In AI Features > AI Summary, enable Auto Summary to automatically sync all recordings to the cloud and generate summaries automatically.

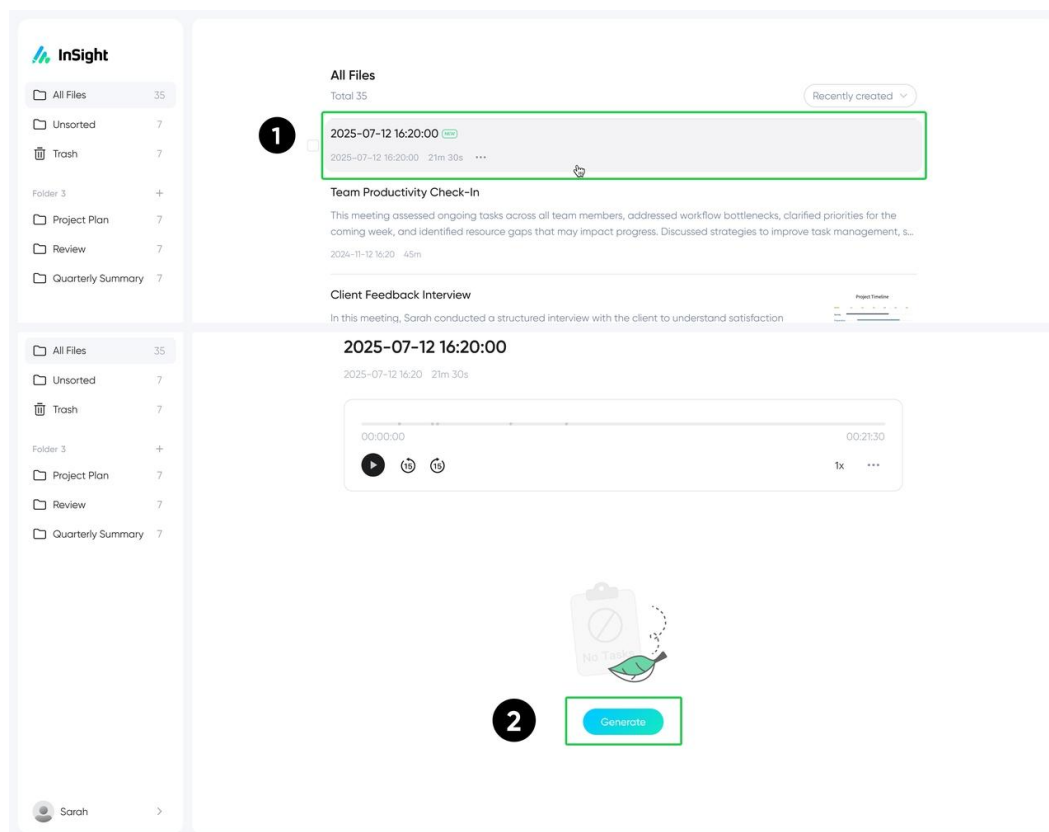

Using with Insta360 Link 2

For scenarios that require both audio and video, the Insta360 Link 2 (sold separately) can be used in combination with Wave, otherwise known as Wavelink.

Connection Steps

1. Use your finger or a thin tool to gently pry open the top cover along its edge and remove it.
2. Mount Insta360 Link 2 on top of the Insta360 Wave, ensuring the contact pins are aligned.
3. Connect Insta360 Wave to your computer via USB-C cable.

Notes:

- When used with Insta360 Link 2, Insta360 Wave can be connected to the computer only via USB-C.
- Currently, when using Insta360 Link 2, only "Noise Reduction" and "Omnidirectional" are supported in order to ensure optimal voice-tracking performance. To use other pickup patterns, please set the Insta360 Link 2 camera to manual adjustment first.
- When reinstalling the top cover, align the arrow on the back of the cover with the arrow besides the contact pins.

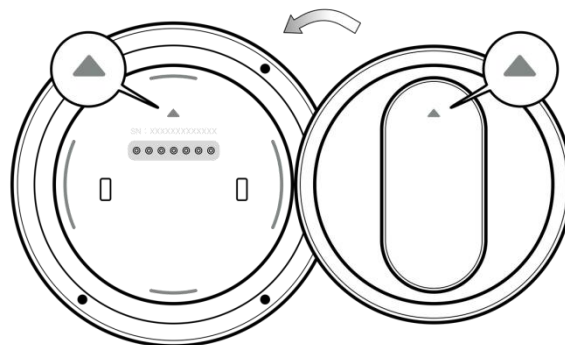

How to Use

Before use, ensure that Insta360 Link 2's firmware has been updated to version 3.2.3.8 or later for voice-tracking compatibility with the Insta360 Wave.

After connection, if a video conference has not yet started, Insta360 Link 2 will enter standby with the lens facing downward.

Before starting a video conference, set Insta360 Link 2 as your video device and the Insta360 Wave as your audio device in your system or conferencing software.

When the conferencing software detects an active video stream, Insta360 Link 2 will automatically power on and start capturing video. By default, Insta360 Link 2 automatically follows the active speaker by default.

You can also switch between Automatic and Manual camera control modes on the Insta360 Wave by going to More > Link 2.

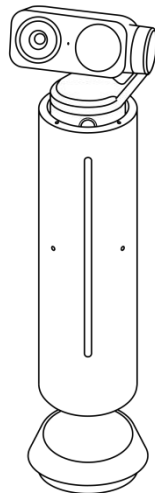

Multi-Device Wireless Connection

Connect up to 3 Insta360 Wave units wirelessly to cover large spaces and ensure everyone's heard, meeting audio needs of large dynamic teams.

Tips: Feature available via future OTA update. Additional Insta360 Waves sold separately.

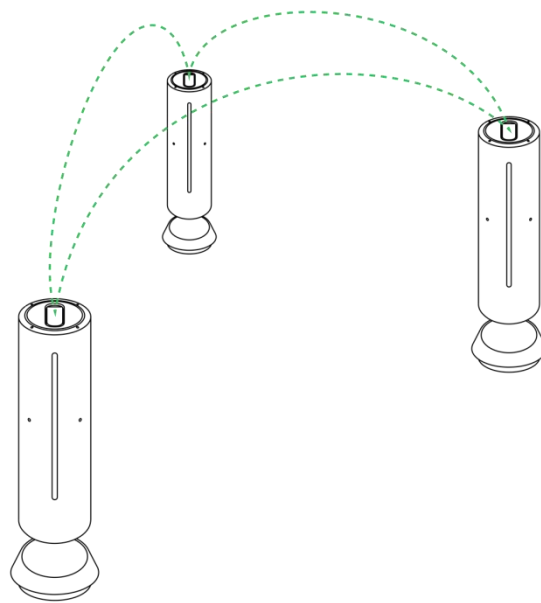

AI Pre-Recording

In Pre-Recording Mode, Insta360 Wave captures everything in the background, then locks in the last 5 minutes once you hit record, serving as a smart backup when things run off-script.

Tips: Feature available via future OTA update.

Maintenance

Find Your Serial Number

1. Product Box

The product's serial number is on the back of the original product box.



2. Product Serial

Remove the top cover to find the serial number beside the connection pins.

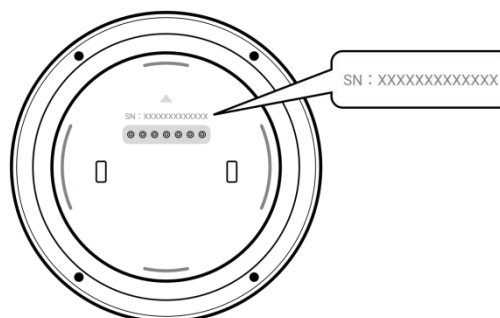

3. Product Touchscreen

On the touchscreen, go to Settings > General > About to find your product model and serial number.



4. Insta360 Wave Controller

The software interface will display the last five digits of the bound product's serial number.

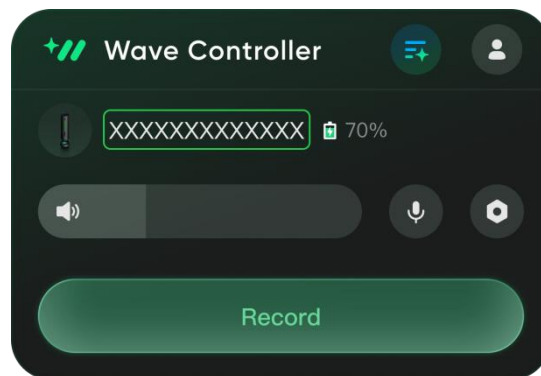

Update Firmware

Method 1: Via Insta360 Wave Controller

Open Wave Controller and go to Settings > About to check your current firmware version. If a newer version is available, follow the onscreen instructions to update.

Method 2: Via USB Mode

1. Connect Insta360 Wave to your computer using a USB-C cable. On the touchscreen, go to Settings > USB Mode > File Transfer.
2. Download the latest firmware from the Insta360 website and copy it to the device.
3. Exit File Transfer. When a pop-up appears on the touchscreen, tap Update.

Method 3: Via Wi-Fi

After connecting Insta360 Wave to Wi-Fi, the system will automatically check if the current firmware is up-to-date. If there is an update available, Insta360 Wave will automatically download the newest firmware when in standby mode. Go to Settings > General > Firmware Update on the touchscreen to update.

Notes:

- Do not disconnect the USB cable while the firmware is being updated via Insta360 Wave Controller or USB Mode.
- Do not use Insta360 Wave during the firmware update.
- For the best experience, it's recommended to update via Insta360 Wave Controller.
- Please ensure the Dongle is inserted before updating. While the device firmware is updating, the Dongle's firmware will also be updated automatically.

Storage and Maintenance

Storage

- Store the product in an environment between -30°C and 70°C .
- Keep the product in a dry and clean environment and away from any heat sources or open flames.

Maintenance

- Cleaning: Before cleaning the product, turn it off and disconnect it from the power source. Clean with a soft, dry, anti-static cloth.
- Maintaining Battery Health: If the product is left unused for an extended period, the battery may be depleted. Please charge it before use.

Safety Information

Environments

1. The device should be used in temperatures between 32°F - 104°F (0°C - 40°C).
2. Keep the device away from any liquids. Do not expose it to moisture. Ensure the environment is dry and clean.
3. Keep the device away from heat sources or open flames, such as candles or portable heaters.

Operation

1. The device contains magnets. Keep it away from pacemakers and other sensitive equipment to prevent interference.
2. Ensure nothing obstructs the device from being extended or retracted when it is powering on or off.
3. The base features a suction cup. To move the device, hold it at the top and gently tilt it to one side. Do not pull it forcefully.
4. The device has a built-in pressure sensor and speaker. Do not touch or press that area.
5. Place the device on a well-ventilated, stable, and level surface.
6. This is a precision-engineered device. Avoid drops or impacts to prevent damage during storage, transport, installation, and use.
7. Do not place heavy objects on the device.
8. Do not disassemble or attempt to repair the device.
9. Keep the volume at an appropriate level to protect your hearing.
10. Please use the accessories provided or authorized by Insta360 only.
11. Before cleaning the device, turn it off and disconnect it from the power source. Clean with a soft, dry, antistatic cloth.

Specifications

General	Model	CINSABCA
	Dimensions	Ø64.3mm (2.53in) Raised: 248mm (9.76in), Collapsed: 198mm (7.80in)
	Weight	490g (17.3 oz)
	Colors	Graphite Black, Arctic White
Audio	Number of Microphones	8
	Microphone Type	MEMS
	Frequency Response	20Hz ~ 20KHz
	Voice Pickup Sampling Rate	48kHz
	Voice Pickup Range	5 meters (16.4 ft)
	Maximum Output Sound Pressure Level	91 dB SPL @ 0.5m/1W
Audio Algorithm	Full-duplex Audio	Yes
	Automatic Noise Suppression (ANS)	AI noise-canceling, eliminates 300+ common noises
	Automatic Gain Control (AGC)	AI AGC
	Automatic Echo Cancellation (AEC)	AI AEC
	Dereverberation	AI-powered
	Beamforming	Omnidirectional, cardioid, supercardioid, figure-of-eight, stereo
	Audio Modes	Noise reduction, original sound

Hardware	Processor	AI Chip
	Storage	4+32GB
	Battery Capacity	9800mAh
	Charging Time	5 hours
	Battery Life (talk time)	Up to 12 hours
	Screen Size	1.82-inch customized touchscreen
	Connection Method	Dongle, Bluetooth, USB
	Device Cascade	Supports wireless linking of 3 devices *Feature available via future OTA update.
	Input	5V/3A, 9V/2.2A
	Power	15W, 19.8W
System Requirements	Computer	Windows 10 or later, MacOS 12 or later.
	Mobile phone/Tablet	Android 10 or later, iOS 12 or later, iPad OS 12 or later.
Communication (Bluetooth)	Operating Frequency	2400 - 2483.5 MHz
	Output Power (E.I.R.P.)	< 10 dBm
Communication (Wi-Fi)	Operating Frequency	2.4 GHz: 2400 - 2483.5 MHz 5.1 GHz: 5150 - 5250 MHz 5.8 GHz: 5725 - 5850 MHz
	Output Power (E.I.R.P.)	2.4 GHz: < 20 dBm 5.1 GHz: < 23 dBm 5.8 GHz: < 23 dBm
Environment	Operating Temperature	0°C ~ 40°C
	Operating Humidity	≤ 80%
	Storage Temperature	-30°C ~ 70°C

Arashi Vision Inc.

ADD: 11th Floor, Building 2, Jinlitong Financial Center, Bao'an District, Shenzhen, Guangdong, China

WEB: www.insta360.com

TEL: 400-833-4360 +1 800 6920 360

EMAIL: service@insta360.com

V1.0